

25"X 22" QUARTZ VANITY TOP

CAVT25RM (Rocky Mountain)



FEATURES

MODEL	CAVT25RM
SIZE	22" L x 25" W x 8-1/2" H
BASIN	12" L x 15" W x 6" H
VANITY TOP	.78" thickness
FAUCET	Single hole; Optional 8" Spread
OVERFLOW	Included
DRAIN	Rear
WEIGHT	50 lbs.
MATERIAL	Quartz; vitreous china

- Made in the USA of Daltile ONE Quartz in Rocky Mountain with a polished finish
- Highly stain resistant; scratch resistant; no sealing required
- Single faucet hole with pilot holes for optional 8 in. widespread faucet
- Includes matching backsplash and pre-attached imported oval vitreous china basin
- Coordinating sidesplash sold separately (CASSRM21)

BEFORE YOU BEGIN INSTALLATION

- Carefully Read the instructions before starting installation.
- This product should be installed by an experienced professional.

If you are missing any part, please stop and contact us immediately at (205) 702-9101.

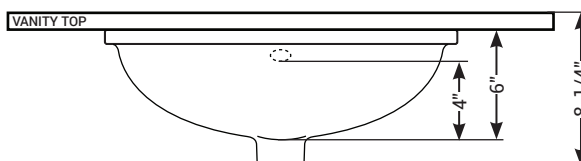
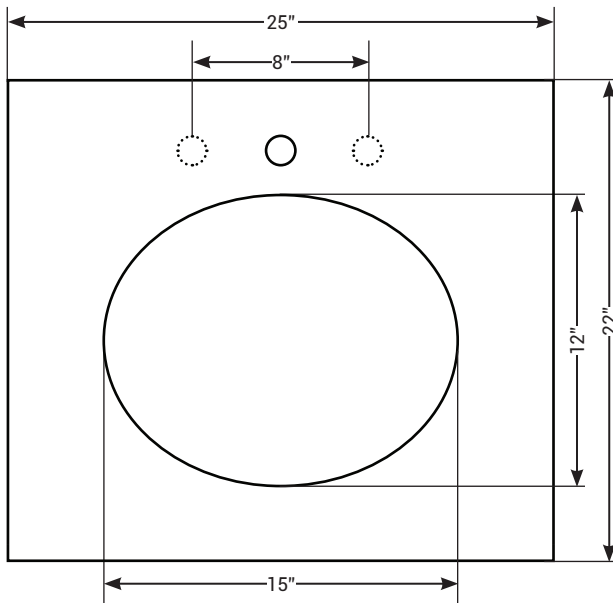
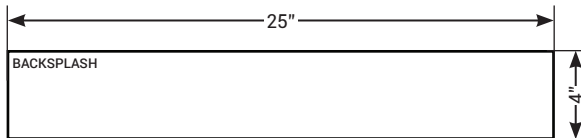

FOR WARRANTY ISSUES OR QUESTIONS, CONTACT CAHABA AT (205) 702-9101.

©2021 CAHABA. ALL RIGHTS RESERVED.

25" X 22" QUARTZ VANITY TOP

Installation Instructions



UNPACK VANITY TOP

Although stone is very durable, it can become extremely fragile if handled incorrectly. Here are a few tips on how to handle the vanity top without damaging it.

1. Remove vanity top from packaging vertically.
2. Carry the vanity top upright, never flat.



OPTIONAL THREE-HOLE INSTALLATION

1. With help, dry fit the countertop on the vanity cabinet you will be using.
2. Place the template provided over the center hole and tape in place. Verify the centers of the knock-out holes are 8" apart.
3. Using a ball peen hammer, from the top, gently hit the centers of both knock-out holes to remove the plugs.
4. Refine the outer edges of the knock-out holes by lightly hammering within the template circles.

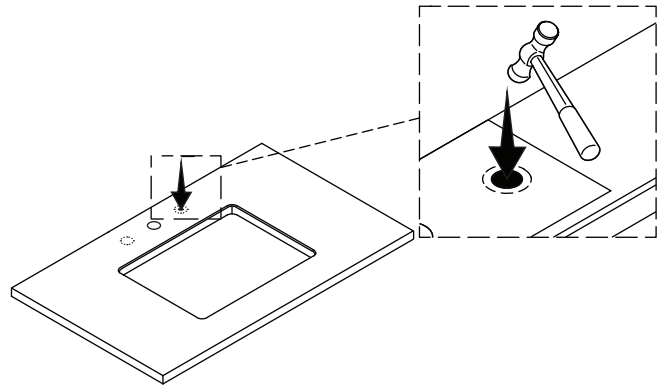

25"X 22" QUARTZ VANITY TOP

Installation Instructions



INSTALL THE VANITY TOP

1. With a helper, stand the vanity top up on its side.

NOTE: This is a good time to install the faucet and drain per manufacturers instructions.

2. Outline the top of the cabinet with silicone.
3. Place the vanity top on the cabinet, back first.
4. Carefully lay the vanity top flat on the cabinet.

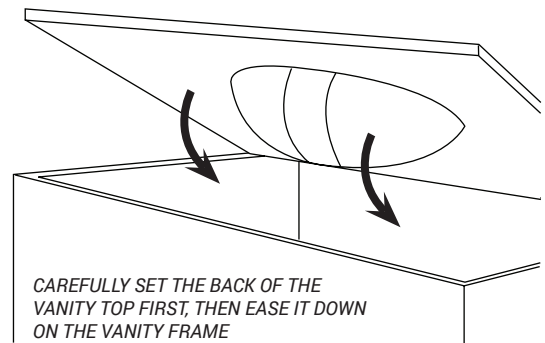
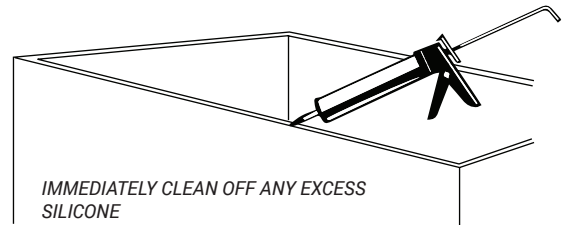

INSTALL THE BACKSPLASH

1. Clean the surface of the vanity top and backsplash.
2. Apply a thin line of silicone along the unfinished edge of the backsplash. Set the backsplash in place.
3. Carefully set the backsplash in place. Immediately remove any excess silicone.

NOTE: Allow the silicone to dry for a full 24 hours.

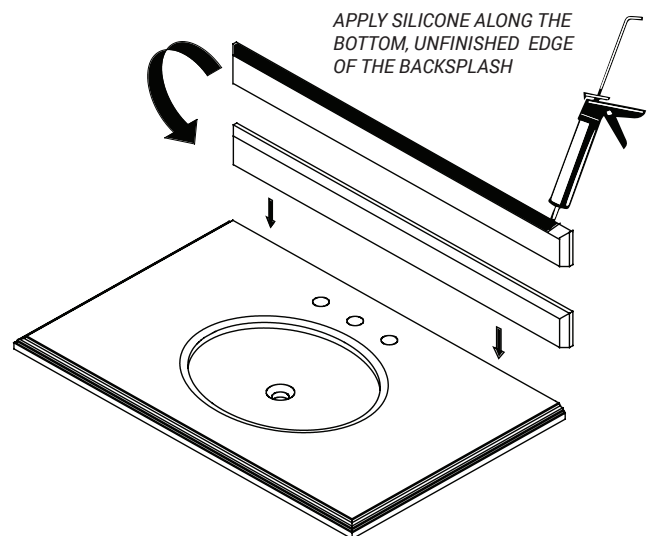

25"X 22" QUARTZ VANITY TOP

Care & Maintenance



Stone countertops (Granite, Marble, etc.) are surprisingly resilient to stains and scratches. However, as a preventative measure, any spills on the stone surfaces should be wiped up within a reasonable amount of time. Don't let liquid sit on the stone overnight. Stones are most prone to staining by oil and acid, so be sure to blot these spills up as soon as they happen. Follow up by cleaning the stone with a mild non-abrasive soap and water. In bathrooms specifically, stone tends to attract soap scum, just like man-made tile. Rinse vanity top with clean, hot water frequently.

The use of sealers is also a powerful preventative measure. Your stone was sealed at the factory, but reapplication is necessary over time. How often is determined by the quality of the sealer used, and the frequency of use. We recommend using a penetrating non-toxic sealer for bath areas, but a food-safe sealer is typically not necessary.

If stains and scratches do occur, there are many things you can do as a consumer to remove them. Remove oil based stains with acetone, mineral spirits, or ammonia. Organic stains like coffee, tea, or juice can be removed with hydrogen peroxide, mixed with a few drops of ammonia.

Water spots or rings are the most common problem with bath vanities, and are caused by minerals left behind when water evaporates. These can be removed by buffing the spots gently with 00 gauge steel wool. Likewise, small nicks and scratches can often be removed the same way. Larger scratches, chips, and resilient stains may require professional help. Please contact your local stonemason for details.

DO'S & DON'TS

- DO use preventative cleaning measures to keep your stone pristine.
- DO use sealers, applied according to the product specific directions.
- DO blot spills quickly, and wash with mild soap and warm water.
- DON'T use harsh bathroom cleaners or grout cleaners on any natural stone.
- DON'T worry if you get a significant stain or scratch that your stone investment is ruined. Virtually anything can be fixed with professional help.

25"X 22" QUARTZ VANITY TOP

Limited 1-Year Warranty



This warranty applies to CAHABA vanity tops installed for commercial and residential use.

CAHABA warrants that, when installed in accordance with the Recognized Plumbing Industry Practice, the vanity tops are free of manufacturing defects for a period of one (1) year from the date of purchase.

We guarantee your satisfaction with each vanity top. Should any vanity top not meet your satisfaction due to a visual defect, simply return it to your retailer with the original packaging, PRIOR TO INSTALLATION, for a replacement.

This warranty applies only to the original purchaser and installation site and is not transferable.

INFORMATION ABOUT YOUR WARRANTY COVERAGE

This warranty does not cover damages or failure attributable to:

- Vanity tops installed with obvious visual defects.
- Defects or damages to vanity tops caused by installation that does not comply strictly with the instructions set forth in CAHABA's installation manual.
- Defects or damage to vanity tops caused by severe accidents (e.g., fire, impacts).
- Damage caused by flooding or standing water from leaking pipes, faucets, household appliances, etc; up to and including flooding and any damage caused by acts of God.

FOR WARRANTY SERVICE

To make a claim, contact CAHABA no later than 30 days following the date of discovery or detection of defect.

Proof of purchase, such as the bill of sale is mandatory when requesting warranty service.

CAHABA reserves the right to designate a representative to inspect the vanity for analysis.

No unauthorized person, installer, dealer, agent or employee of CAHABA or any representative is entitled to assume any liability on behalf of CAHABA relating to the sale of this product or has the authority to increase or alter the obligations or limitations of this warranty.

THE SOLE REMEDY PROVIDED BY THIS WARRANTY IS THE REPAIR OR REPLACEMENT OF DEFECTIVE PRODUCTS.

THIS WARRANTY DOES NOT COVER THE COST OF REMOVAL OR INSTALLATION OF NEW PRODUCTS. THE WARRANTY WILL BE VOID IF THIS ITEM IS INSTALLED WITH OBVIOUS VISUAL DEFECTS.