

PRODUCT SPECIFICATIONS

Elkay Lustertone™ Classic Stainless Steel 25" x 22" x 6", Single Bowl Drop-in Classroom ADA Sink. Sink is manufactured from 18 gauge 304 Stainless Steel with a Lustrous Satin finish, Rear Center drain placement, and Bottom only pads.

Installation Type:	Drop-in
Material:	304 Stainless Steel
Finish:	Lustrous Satin
Gauge:	18
Sound Deadening:	Bottom only pads
Number of Bowls:	1
Sink Dimensions:	25" x 22" x 6"
Bowl 1 Dimensions:	16" x 19" x 5-7/8"
Drain Size:	3-1/2" (89mm)
Drain Location:	Rear Center
Minimum Cabinet Size:	30"
Mounting Hardware:	Part # 64090012 included for countertops up to 3/4" (19mm) thick
Cutout Template #:	1000001188

Template is available for download at [elkay.com](#)

Cutout Dimensions for Top Mount Installation:

24-3/8" x 21-3/8" (619mm x 543mm) with 1-1/2" (38mm) corner radius

Hole Drilling Configurations:

1-1/2" (38mm) Diameter Faucet Holes on 4" (102mm) Centers
1-1/8" (29mm) Diameter Slotted Hole

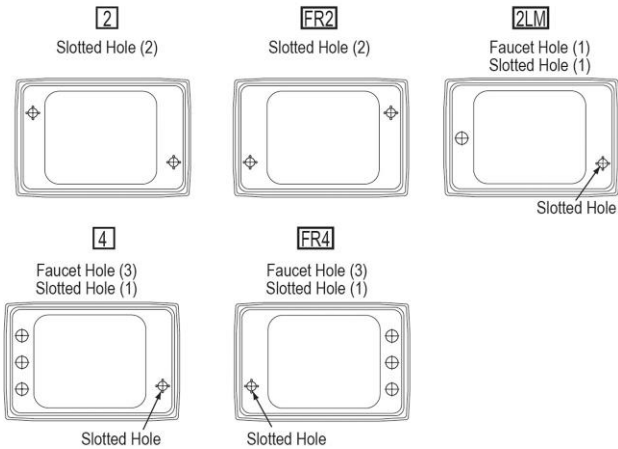

AMERICAN PRIDE. A LIFETIME TRADITION.
Like your family, the Elkay family has values and traditions that endure. For almost a century, Elkay has been a family-owned and operated company, providing thousands of jobs that support our families and communities.



Product Compliance: ADA & ICC A117.1
ASME A112.19.3/CSA B45.4
BUY AMERICAN ACT



Sinks are listed by IAPMO® as meeting the applicable requirements of the Uniform Plumbing Code®, International Plumbing Code®, and National Plumbing Code of Canada.



Complies with ADA & ICC A117.1 accessibility requirements when installed according to the requirements outlined in these standards.

[Clean and Care Manual \(PDF\)](#)
[Installation Instructions \(PDF\)](#)
[Limited Lifetime Warranty \(PDF\)](#)

Similar models are available with: Quick-Clip Mounting System, additional ADA depths

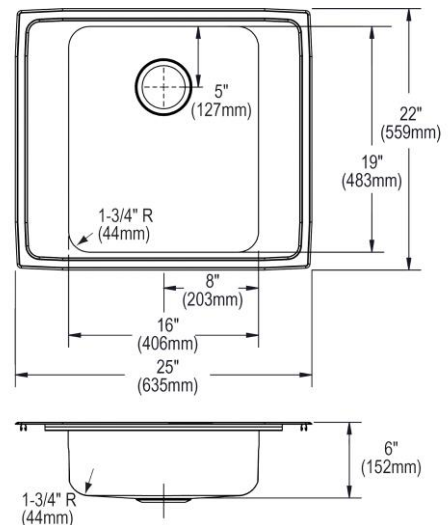

PART: _____ QTY: _____
PROJECT: _____
CONTACT: _____
DATE: _____
NOTES: _____
APPROVAL: _____

In keeping with our policy of continuing product improvement, Elkay reserves the right to change product specifications without notice. Please visit [elkay.com](#) for the most current version of Elkay product specification sheets. This specification describes an Elkay product with design, quality, and functional benefits to the user. When making a comparison of other producers' offerings, be certain these features are not overlooked.

Installation Profile:



OPTIONAL ACCESSORIES

Hardware:	LK364, LK463
Sinkmate:	LKSMHSL

In keeping with our policy of continuing product improvement, Elkay reserves the right to change product specifications without notice. Please visit elkay.com for the most current version of Elkay product specification sheets. This specification describes an Elkay product with design, quality, and functional benefits to the user. When making a comparison of other producers' offerings, be certain these features are not overlooked.