

PRODUCT SPECIFICATIONS

Elkay Weldbilt Stainless Steel 55-1/2" x 27-1/2" x 14" Floor Mount, Double Compartment Scullery Sink with Drainboard. Sink is manufactured from 14 gauge 304 Stainless Steel with a Buffed Satin finish, Center drain placement. Sinks supported by (4) 16 gauge stainless steel, 1-5/8" O.D. tubular legs with bullet shaped feet adjustable up to 1".

Material:	304 Stainless Steel
Finish:	Buffed Satin
Gauge:	14
Number of Bowls:	2
Sink Dimensions:	55-1/2" x 27-1/2" x 44"
Bowl 1 Dimensions:	15" x 24" x 14"
Bowl 2 Dimensions:	15" x 24" x 14"
Drainboard Location:	Right
Drainboard Size:	24"
Backsplash Height:	8"
Leg Type:	Stainless Steel
Drain Size:	3-1/2" (89mm)
Drain Location:	Center

Custom Options	
<input type="checkbox"/> Type 316 Stainless Steel	
Drain Location	
<input type="checkbox"/> Right Rear	<input type="checkbox"/> Left Rear
<input type="checkbox"/> Center	<input type="checkbox"/> Center Rear
Overflow Location	
<input type="checkbox"/> Front	<input type="checkbox"/> Left
<input type="checkbox"/> Rear	<input type="checkbox"/> Right
Alternate Punching	
<input type="checkbox"/> Faucet Model:	<input type="checkbox"/> Punch Required:
Sink Size	
<input type="checkbox"/> Bowl Width:	<input type="checkbox"/> Drainboard Width:
<input type="checkbox"/> Bowl Depth:	<input type="checkbox"/> Backsplash Height:

*Options available if applicable

**Drainboards over 25-1/2" wide furnished with one tubular leg.

***Drainboards over 48" wide furnished with two tubular legs.



AMERICAN PRIDE. A LIFETIME TRADITION. Like your family, the Elkay family has values and traditions that endure. For almost a century, Elkay has been a family-owned and operated company, providing thousands of jobs that support our families and communities.



Product Compliance: ASME A112.19.3/CSA B45.4
BUY AMERICAN ACT
NSF 2



[Clean and Care Manual \(PDF\)](#)
[Limited Warranty \(PDF\)](#)

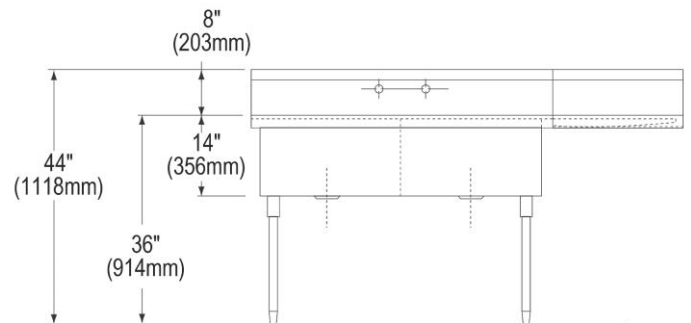
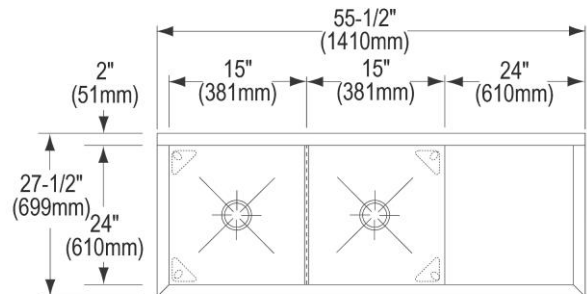

PART: _____ QTY: _____

PROJECT: _____

CONTACT: _____

DATE: _____

NOTES: _____

APPROVAL: _____

In keeping with our policy of continuing product improvement, Elkay reserves the right to change product specifications without notice. Please visit elkay.com for the most current version of Elkay product specification sheets. This specification describes an Elkay product with design, quality, and functional benefits to the user. When making a comparison of other producers' offerings, be certain these features are not overlooked.

In keeping with our policy of continuing product improvement, Elkay reserves the right to change product specifications without notice. Please visit elkay.com for the most current version of Elkay product specification sheets. This specification describes an Elkay product with design, quality, and functional benefits to the user. When making a comparison of other producers' offerings, be certain these features are not overlooked.