

Installing Vanities	1
Montlake & Montlake View	1
Alki, Belltown, Newhalem, Birch Bay, Wallingford & Ravenna	2
SoDo (wall mounted)	2
EuroLavs	3
Installing Medicine Cabinets	4
Installing Wall Mirrors	7
Removing, Re-installing & Adjusting Doors and Drawers	8
Removing & Re-installing Doors	8
Adjusting Door Soft Close Effect	8
Adjusting Door Alignment	9
Removing & Re-installing Drawers	10
Adjusting Drawer Face Alignment	10
Installing Vanity Tops	11
Care & Cleaning	12

If you have questions, call our customer service
Toll Free 1-800-445-0494, 7AM - 4PM Pacific Coast Time.

Thank you for purchasing Strasser Woodenworks Products that are always
crafted in the USA for your bath.

INSTALLING VANITIES

video For your convenience, see our installation videos by visiting strasserwood.com and clicking "installation and care."

CAUTION! Always remove drawers and doors from your cabinets and store them away from the work area during installation (see pages 8 & 10). This will make your cabinets lighter, easier to move and position, and safer to handle. Drawers and doors can open unexpectedly and unbalance the cabinet while you are moving it, causing personal injury or damage to your cabinet. Plus, drawer and door faces will be protected from damage during installation if stored away from your project. Damage caused during installation is not covered by warranty.

The key to a good installation of any vanity or vanity ensemble is to understand that walls and floors are never exactly level, plumb, or square.

Securing a vanity or ensemble to your walls is important. However, forcing a square cabinet to fit against not-so-square walls will distort the cabinet frame and cause drawer and door hardware to mis-align and bind. Never close gaps by overly tightening the securing screws. Always use shims between the cabinet and wall and floor where gaps exist before tightening securing screws. While our hardware is adjustable to help compensate visually for some mis-alignment, the drawers may not open and close smoothly if you don't follow this basic procedure.

Installing Montlake & Montlake View Vanities and Ensembles

Place your cabinet into approximate position.

If you are installing an ensemble of more than one piece, clamp components together making sure that they are accurately mated and the top edges are exactly aligned. Drill pilot holes and screw components together. We recommend four screws per pairing.

Place the vanity or ensemble into its exact final position and level  units with shimming underneath where necessary.

Vanities must be secured to wall studs in at least two positions along the back and one in the side, if the side is against a wall. Shim where necessary at securing points between wall and cabinet if the wall is not exactly straight or plumb.

Installing Montlake Linen Uppers

Linen Uppers are always packed "upside down" to prevent damage to the doors that overhang the frame. The doors will cover the joint where the upper and lower units join. Cut away the box and remove inner wrappings. Remove all wood shipping supports leaving in place the 90° angle brackets. These brackets will fit inside the lower unit and will be used to secure the Linen Upper to the Linen Lower. Remove the doors and place well away from your work area (see page 7).

Always have two people lift and position the Linen Upper onto the Linen Lower. Make sure connecting brackets clear Linen Lower edges and fit into place. Adjust the two Linen halves to mate exactly. From inside the Linen Lower, carefully drill pilot holes and secure brackets with provided screws.

Additionally, it is especially imperative that any tall cabinet – like a linen cabinet – must be secured to the wall.

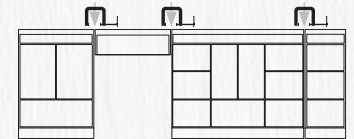

Installing Alki, Belltown, Newhalem, Birch Bay, Wallingford & Ravenna Vanities and Linen Cabinets

Place the vanity or linen into it's exact final position and level where necessary using the leveler feet.

Vanities must be secured to wall studs in at least two positions along the back and one in the side, if the side is against a wall. Shim where necessary at securing points between wall and cabinet if the wall is not exactly straight or plumb.



Additionally, it is especially imperative that any tall cabinet – like a linen cabinet – must be secured to the wall. We include hardware for this but your specific installation may require different/additional anchoring.

SPECIAL NOTE

Serious or fatal crushing injuries can occur from a linen cabinet tipping over.

To help prevent tipover:

- Install provided tipover restraint
- Place heaviest items in the lower drawers
- Do not place heavy objects on top of this product
- Never allow children to climb or hang on drawers, doors or shelves
- Do not open more than one drawer at a time.

Use of tipover restraints may only reduce, but not eliminate, the risk of tipover.

We supply attachment hardware with your order but some applications may need different/additional hardware. Manufacturer assumes no liability for improper installation or excessive loads placed on screws, brackets or straps.

Installing SoDo Vanities & Drawer Banks

CAUTION! When mounting heavy fixtures onto a wall, extra care must be exercised to ensure a safe and durable installation.

- **ALWAYS** use the Mounting Bar system to distribute the load evenly.
- **ALWAYS** use adequate fastening devices into adequate holding material.
- **If you are not familiar with loads, holding materials, proper fastening devices/techniques; consult a professional.**

These instructions are for installing your SoDo wall-mount vanity or ensemble to a wall constructed of 2" X 4" wood studs covered with 1/2" gypsum board/sheet rock. Any other installation must be undertaken by a qualified construction specialist with knowledge of your specific application.

Install SoDo vanities and drawer banks using 5/16" X 3 1/2" lag screws with washers (provided). Lag screws must engage at least two wall studs and the lag screws must not be more than 3" from cabinet sides. Otherwise, a cross member between wall studs should be installed and a qualified contractor should be consulted for installation. (See illustration 1.)

continued next page

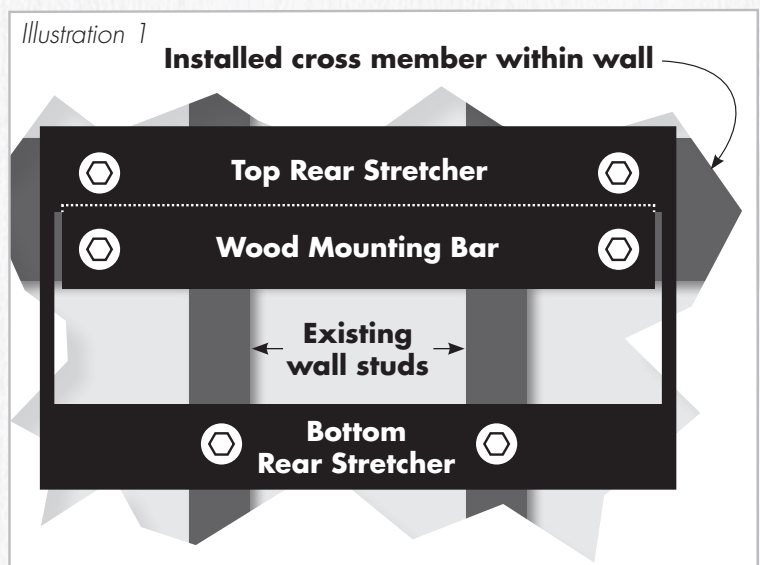

Determine final vanity cabinet top height (excluding counter top) and center, and mark on wall. Measure down $8\frac{7}{8}$ " to mark where the bottom edge of the Mounting Bar will be on your wall.

(See illustration 2.)

Determine side-to-side vanity position on your wall. Mounting lag screws for wood Mounting Bar and upper rear stretcher must be within 3" of vanity sides and must engage stud centers or an installed cross member.

Drill $\frac{3}{8}$ " holes into the wood mounting bar (to allow the $\frac{5}{16}$ " lag screws to pull Mounting Bar snugly onto wall).

Place the Mounting Bar in position on the wall again and

mark the wall for drilling into wall studs. Drill $\frac{3}{16}$ " pilot holes into wall and wall studs for $\frac{5}{16}$ " lag screws. **It is important to drill into stud center.** If installing an ensemble consisting of multiple components, carefully plan mounting bar placement for all cabinets first.

Secure the wood Mounting Bar(s) to the wall. **Do not force the wood Mounting Bar** to conform with a wall that is not perfectly flat. Doing so will make it impossible to mate the cabinet to the Mounting Bar. Use shims where necessary. Hang the cabinet(s) by mating the bevels of the Mounting Bar(s) and cabinet upper rear stretcher(s).

Secure the cabinet(s) to the wall with additional lag screws through the upper and lower rear stretchers. Drill pilot holes through stretchers into stud centers. Enlarge holes slightly in stretchers so that tightening the lag screws will snug the stretchers against the wall. Shim where necessary to compensate for a wall that is not flat or plumb. If mounting multiple components, drill pilot holes and screw components together. We recommend four screws per pairing.

CAUTION! Never stand or sit on your wall mounted SoDo Vanity.

Installing EuroLavs

EuroLav sets are comprised of a base and a top.

Installing a EuroLav Style base is as simple as setting the cabinet in place and levelling with its leveler feet (Wallingford, Ravenna) or shims (Montlake).

Place the basin top onto the base and check for fit against the wall. There is "play" intentionally built into the base-to-top fit allowing movement to get the best top-to-wall fit. Most likely, you will need to adjust the fit by shimming between the top and the base for the best fit. Check also that the top is level and shim accordingly. Once you are satisfied with the fit and positioning, we recommend applying Silicone type bathroom caulk to make a permanent bond between basin and base.

EuroLavs must be secured to a wall stud. Shim if necessary between wall and cabinet if the wall is not exactly straight or plumb, or if the base is not against the wall with proper basin top wall fit.

Re-install Doors and Drawers

Once your cabinets are in their final positions and secured, re-install and adjust doors and drawers according to directions on pages 8 and 10.

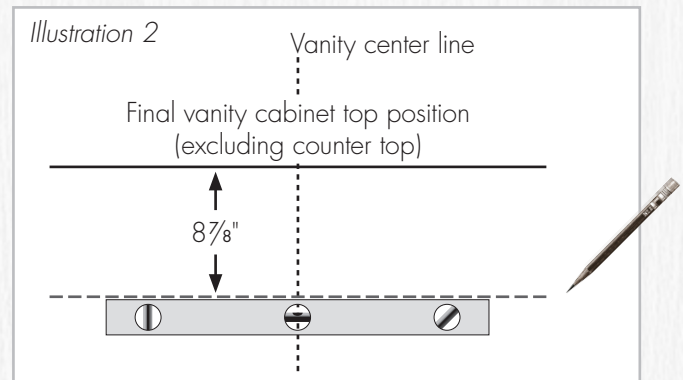

INSTALLING MEDICINE CABINETS

CAUTION! Always remove doors from your cabinets during installation (see page 7) and store them away from the work area. This will make your cabinets lighter, easier to move and position, and safer to handle. Doors open unexpectedly and unbalance the cabinet while you are moving it, causing personal injury or damage to your cabinet. Plus, door faces will be protected from damage during installation if stored away from your project. **Take special care to not damage mirrors: store doors with glass side toward a wall.** Damage caused during installation is not covered by warranty.

video For your convenience, see our video on this topic. Go to strasserwood.com and click "installation and care" to find our videos.

Whether you have a medicine cabinet with traditional lights, LED light bar or just a crown molding top, the mounting process is the same. The overall height will differ so consider that in your planning.

Our medicine cabinet mounting system

is easy to use, convenient and very strong.

Determine the desired location of the medicine cabinet box (before lights or crown molding are installed) and mark the wall, with a pencil, at top center of the cabinet box. (See *illustration 1*.)

Measure down 3³/₄" and make a level horizontal line. The top edge of the mounting bar will be at this line.

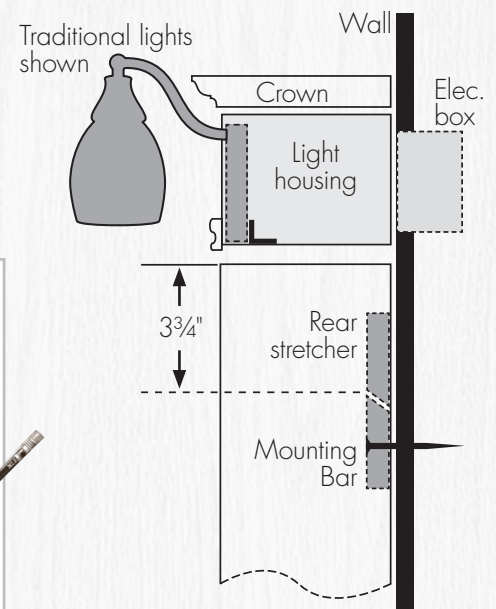
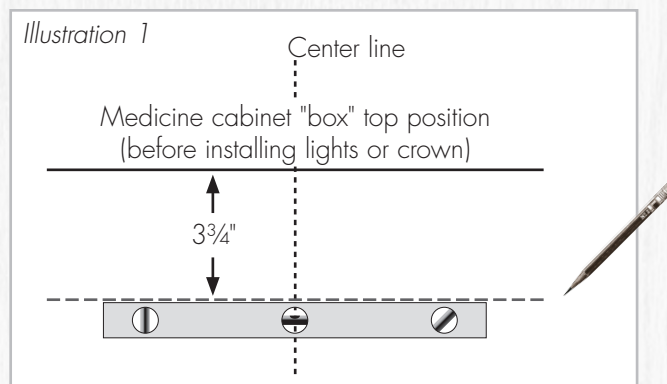

Locate wall studs. Use two to four large (min. 3") screws to secure the mounting bar to the wall. Pre-drill screw holes in the bar slightly larger than the screws being used so that tightening them will snug the mounting bar against the wall. Run screws through bar, sheetrock and well into studs. If you are not familiar with types of screws, load, or how to do this for your specific application; ask a construction professional. **Do not force the wood Mounting Bar** to conform with a wall that is not perfectly flat. Doing so will make it impossible to mate the cabinet to the Mounting Bar. Use shims where necessary.

Place medicine cabinet against the wall and slide down until the medicine cabinet's rear stretcher mates with the installed mounting bar.

continued next page

Electrical for Medicine Cabinets

You are either installing your medicine cabinet with lights or without. If without, simply secure the crown to the top of the cabinet.

If your medicine cabinet has lights, have your electrician mount an electrical junction box so that power will be available as indicated by the gray area in the illustration to the right. (See illustration 1.)

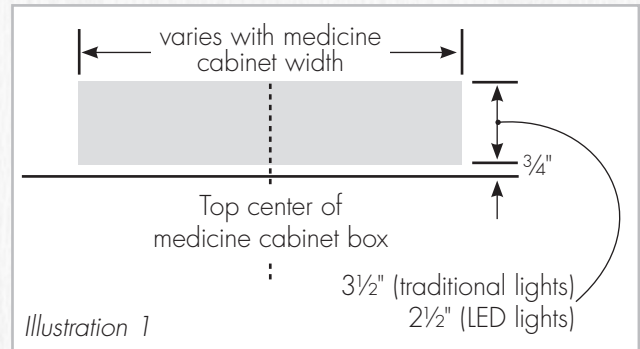

Traditional lights: Attach the light housing to the medicine cabinet box securely with screws. Slide the lighting fixture into the housing as shown and secure with the supplied angle pieces.

Light globes fit over the porcelain sockets and are held in place with supplied metal nuts.

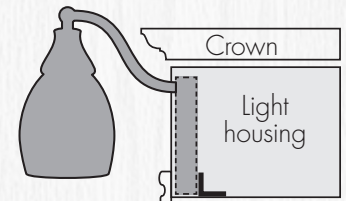
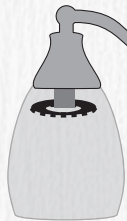

Traditional light fixtures use candelabra base bulbs available in a variety of wattages and types. We recommend dimmable LED bulbs and your personal taste will dictate the wattage you choose. You may also use standard incandescent bulbs but do not exceed 40 watt rating. Be sure to use bulbs rated for "base up" applications.



LED lighting: Attach the light housing to the medicine cabinet box securely with screws. Slide the threaded support posts of the LED lightbar through the keyed square trim pieces and into the two holes in the light housing. Secure with supplied washers and nuts. Power is supplied by the accompanying LED driver, which is wired into your installed switched junction box.

Your electrician can now connect the light fixture wiring at the electric junction box according to code. Then secure the crown onto the light housing and you're finished.

Installing Recessed Medicine Cabinets

The rough opening for 20" wide recessed medicine cabinets is 19 $\frac{1}{4}$ " wide by 29 $\frac{3}{4}$ " high; for the 15 $\frac{1}{4}$ " wide model the rough opening is 14 $\frac{1}{2}$ " wide by 29 $\frac{3}{4}$ " high. The rough opening must be at least 4" deep. The opening should be framed in for strength and to provide for cabinet attachment.

The cabinet box must be level for proper door operation.

Changing your medicine cabinet's door swing

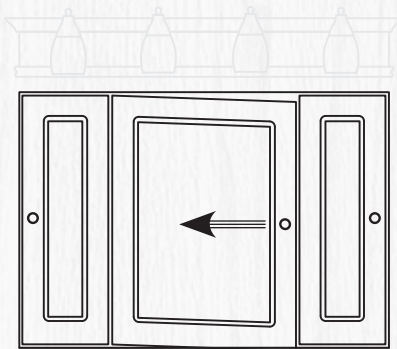

For Tri-View
& Single-Door (surface
or recessed)
Medicine Cabinets:
To change the door swing from right-
to-left to *left-to-right* or vice versa,
simple rotate the cabinet body
180 degrees and hang
on your wall.

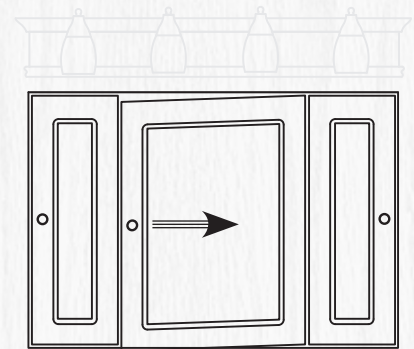

INSTALLING MIRRORS

Our mirror mounting system is easy to use, convenient, and very secure.

Determine the desired location of the mirror and mark the wall at top center of the mirror. (See *Illustration 1.*)

Measure "X" on your mirror. (See *Illustration 2.*)

Measure down "X" on your wall from the mark designating mirror top center. Using a level, mark the positions of the cleat mounting holes as shown in *Illustration 3.*

Screw cleat half B to the wall. If you are not familiar with types of screws, load, or how to do this for your specific application; ask at a home center.

video For your convenience, see our video on this topic. Go to strasserwood.com and click "installation and care" to find our videos.

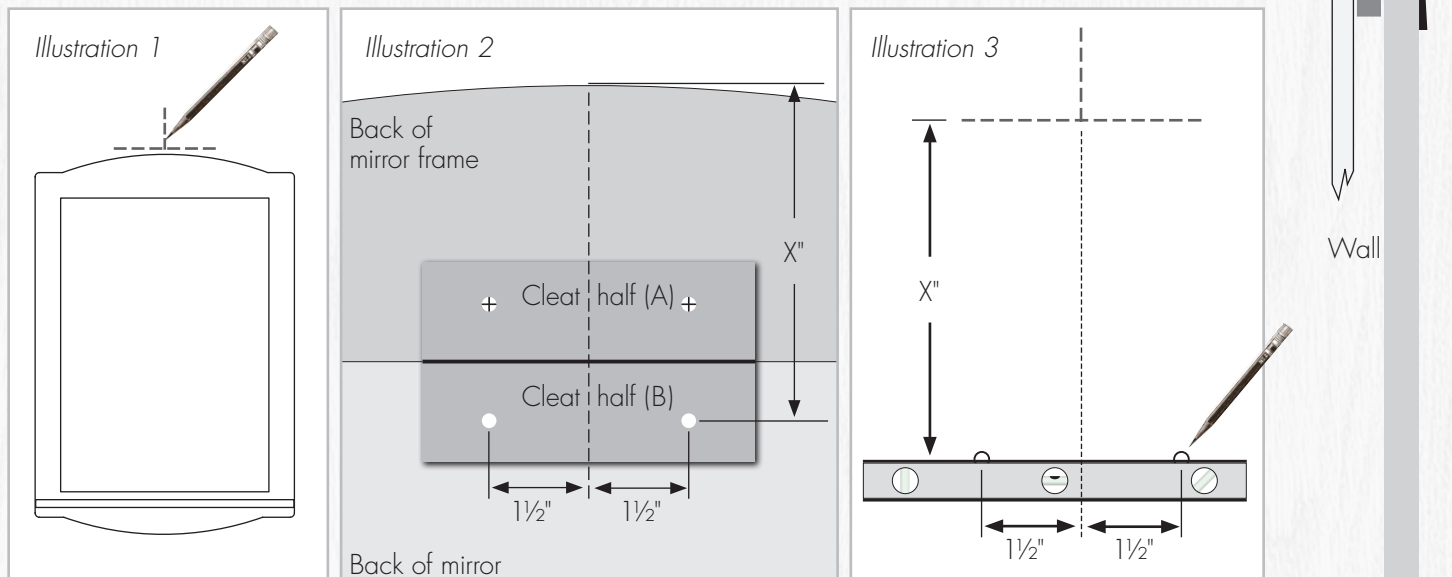

Installing Newhalem Mirrors

Because our Newhalem mirror is large and heavy, you must be certain to attached the mounting cleats to wall studs. The mirrors-side cleat halves will likely need to be moved from their positions as shipped to mate with the wall-side halves.

Do not try to hang your Newhalem mirror using "molly," toggle or other drywall anchor devices. **If you are not familiar with loads, holding materials, proper fastening devices/techniques; consult a professional.**

REMOVING AND RE-INSTALLING DOORS with 6-way Adjustable Hinges

To remove door:

Depress small lever as indicated on both hinges of a door. Rotate the door outward from cabinet, disengage the hinges and remove.

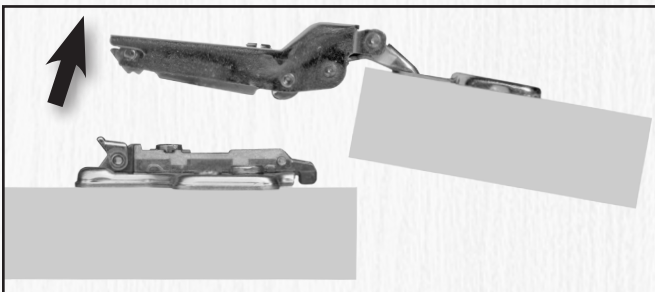
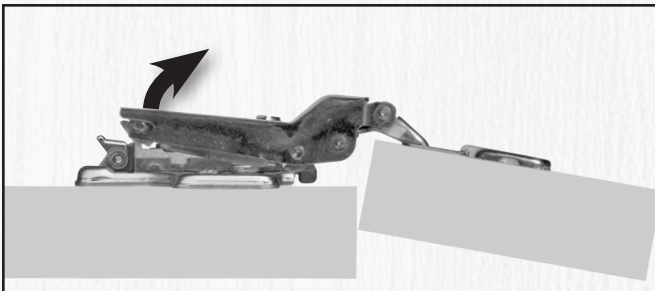
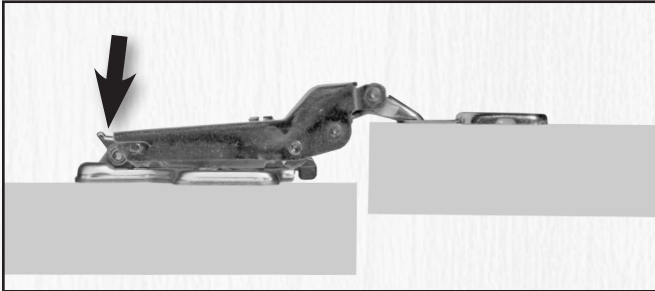

To re-install door:

Engage both hinges by lining up hinge hooks and pins. Push each hinge into the rail until it clicks locked.

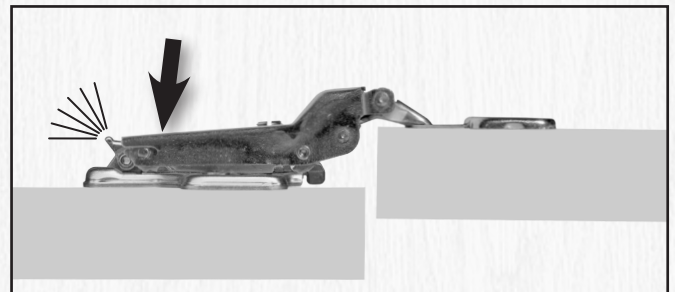
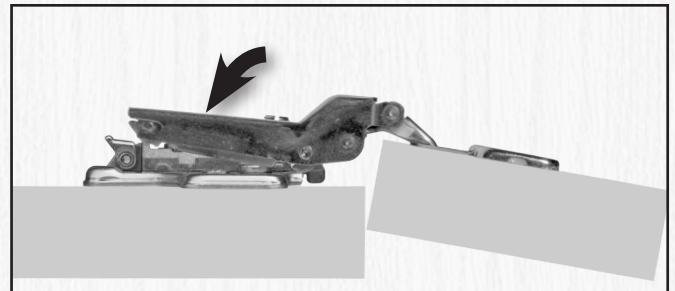
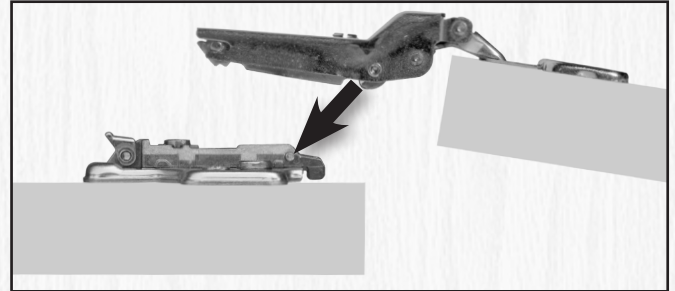

ADJUSTING DOOR SOFT CLOSE

You can adjust where, on the door swing, the soft close effect slows the door closing. The adjustment is on the top hinge of each door.

Slide the tab up for a softer close, one that slows the door sooner in its swing inward.

Slide the tab down for a less aggressive slowing effect.

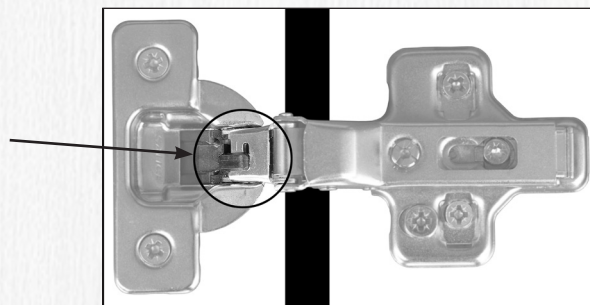

ADJUSTING DOOR FACE ALIGNMENT

video For your convenience, see our video on this topic. Go to strasserwood.com click "installation and care" to find our videos.

Adjusting door up & down

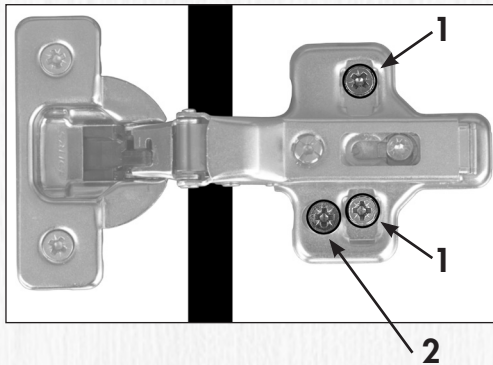
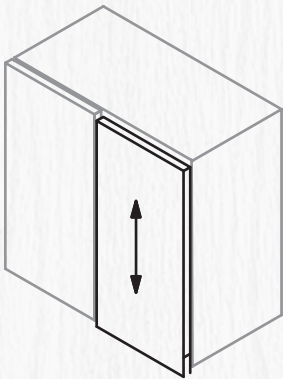

Loosen screws **(1)** on both hinges. Turn screw **(2)** equally on each hinge to move both hinges up/down.
Never adjust one hinge without also adjusting the other hinge.

Adjusting door in & out

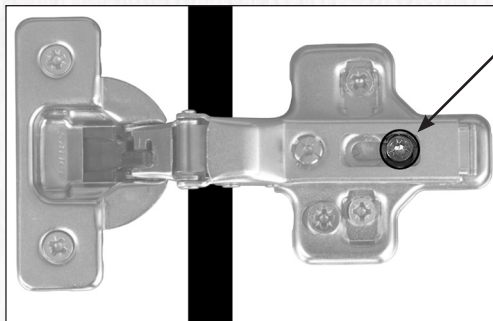
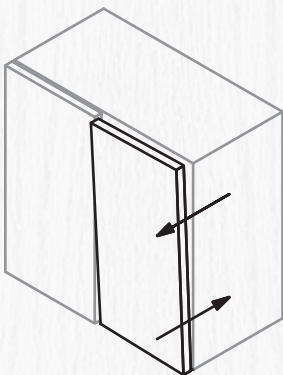

Turn screw indicated to adjust door in/out.

Note: as the door corner at the hinge moves in one direction, the diagonally opposite corner moves in the other direction.



Adjusting door left & right

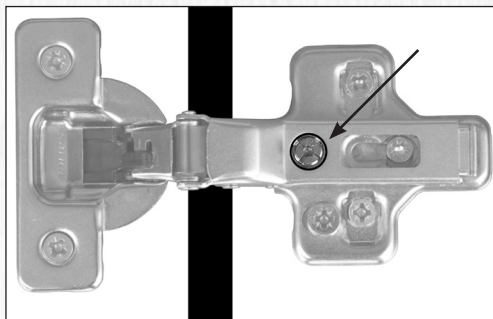
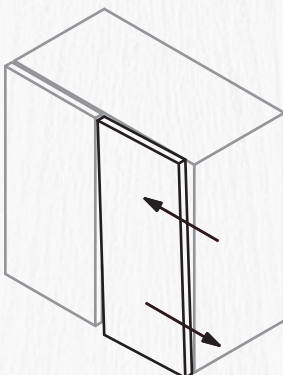

Simply turn indicated screw to adjust door left/right.

REMOVING & RE-INSTALLING DRAWERS

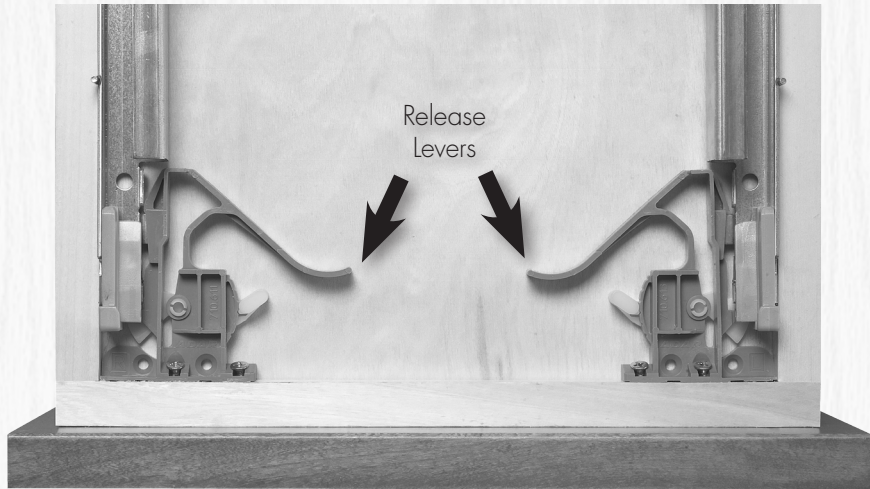

To remove a drawer, open the drawer, reach under it and pull the release levers toward the drawer front. The drawer is now released from the glides. Pull the drawer box toward you and upward to remove.

To replace, simply set the drawer box onto the rails and push closed. Drawer will automatically re-engage with the glides.

ADJUSTING DRAWER FACE ALIGNMENT

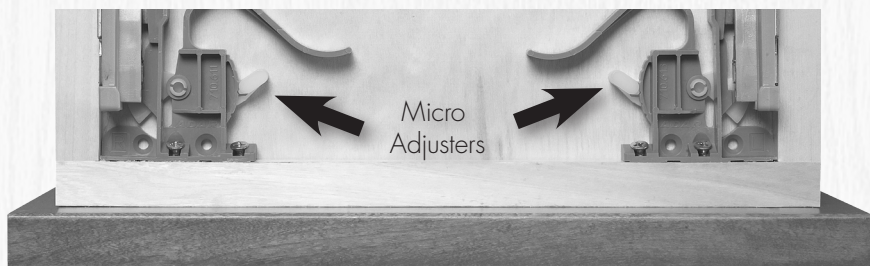

To adjust drawer face alignment begin by setting the micro adjusters to their middle position as shown. This will allow you to fine-tune the face position later.

Then, loosen the two indicated screws inside the drawer box slightly and move the face to the desired position. Once you are satisfied, tighten all of these screws on all drawers.

Finally, screw the provided set screws into the small holes beneath the adjusting screws to "lock" the position of the faces relative to the drawer boxes.

Fine tune with the micro adjusters. Each one will raise or lower one side of drawer front.



video For your convenience, see our video on this topic. Go to strasserwood.com click "installation and care" to find our videos.

INSTALLING VANITY TOPS

Strasser Woodenworks offers two types of tops to complement our vanities: classic granite and quartz with installed under-mount basins and vitreous china one-piece tops with integral basins. The installation procedure for either is the same.

Keep in mind that all tops are heavy but the stone tops are extremely heavy. Two installers will be required to lift and place the top!

Ensure that your vanity installation has been completed and that your vanity is properly and solidly shimmed and attached so that the top edges are level and flat. All bottom edges or legs must be in solid contact with the floor. A low corner or edge could lead to cracking of the top over time.

Place the top onto sawhorses or other solid support and install your faucet set(s) while you can still easily access the underside. Then set the top onto the vanity to make sure everything clears. For example, will you be able to connect supply lines? Now is the time to check! Remove the top and make any modifications to your vanity or structure before proceeding.

Once you are satisfied of the fit and clearances, you are ready to install your top permanently. Remove any dust, dirt and burrs from the vanity top edges and apply a bead of silicone caulk to all edges that will be in contact with the top. The silicone will make a flexible support to help distribute weight evenly. Set the top in place, trying to disturb the caulk as little as possible.

CAUTION! Keep your hands and fingers away from the gap under the top as you lower it onto the vanity. Make a final check for fit and you're finished except for installing backsplash and side splash pieces if being used in your application.

CARE AND CLEANING

Vanities & Other Cabinets

To clean your vanity, simply wipe down your vanity with a damp soft cloth and, only if necessary, a small amount of non-bleach, non-abrasive household cleanser. Treat your Strasser Woodenworks vanity like any other piece of furniture.

- **Never** use any abrasives or abrasive cleansers on your Strasser Woodenworks cabinets
- **Never** use a scouring pad or sponge.
- **Never** use bleach, solvents (like nail polish remover), or harsh cleaners on your cabinets.
- **Clean mirrors** with a glass cleaner that does not contain ammonia or vinegar and use only on glass surfaces
- **Never** use a glass cleaner on finished frames of mirrors, medicine cabinet mirror door frames, or any other non-glass surfaces of your Strasser Woodenworks cabinets! Doing so will, over time, damage the finish.
- **Never** leave standing water on the floor in contact with your vanity base or legs.
- **Do not** leave wet linen in contact with finished wood surfaces for long periods of time

Stone and Vitreous China Tops

Granite and quartz surfaces are tough but will scratch or can become dulled with use of abrasive pads and/or scouring cleaners.

China tops are very resistant to staining but will still dull over time if harsh scouring cleansers and pads are used.

For routine cleaning, simply wipe down your vanity top with a damp cloth or paper towel and, if necessary, a small amount of non-bleach, non-abrasive household cleanser.

- **Wipe up spills** as soon as possible, even though stone surfaces resists permanent staining. For stubborn or dried spills, use a nonabrasive cleaning pad with a glass & surface cleaner or comparable cleaning product.
- **Never stand or sit** on a stone or china top. Applying an uneven pressure to tops may cause cracking!
- **Never** pour boiling or very hot water into a ceramic basin or onto a ceramic top. Doing so will crack the basin or top.
- **Be careful** to not drop heavy objects onto china tops or into basins.
- **Avoid** using cleaners that contain bleach on stone tops.
- **Avoid** exposing stone surfaces to strong chemicals and solvents.
- **Keep away** nail polish remover, bleach, bluing, permanent markers or inks from your stone vanity tops.

Clean any stains immediately. If they persist, moisten a cloth with Goo Gone®, or a comparable product, and rub into the stain. Rinse thoroughly with warm water to remove any cleaner residue.